

deXpro Ltd

01244 631370

Sales@dexprouk.com

Feisty Mini High Speed Hand Dryer

Operation Instruction

Product Features	1
Technical Specifications	1
Packing List	1
Name Of Componets	2
Notice Items Before Installation	2-3
Installation	3
Operation	4
General Safety Information	4
Guarantee	5

Thank you for choosing our Feisty Mini Hand Dryer.
 Please read carefully before attempting to install, operate or service the product.
 Protect yourself and others by observing all safety information.
 Retain instructions for future reference.

GENERAL MAINTENANCE

1. Surfaces of the unit should be cleaned with a soft cloth dampened with neutral cleaning agent. Do not use caustic solutions or abrasive cleaning materials on the drier.
2. Prevent the water from flowing or spilling into the interiors of machine.
3. Always use genuine spare parts when old parts need to be replaced.
4. Disconnect the power source and contact with qualified maintenance personnel for service when machine error happened
5. Must be pulled out the power supply and placed in the shade and dry place if don't use the device in a long time

GUARANTEE

1. This product is guaranteed for a period of 12 months from the date of purchase against faulty components and manufacturing defects.
2. This warranty does not cover wear and tear, or misuse and abuse.
 Transportation, freight cost and labor costs are excluded.
3. Before taking any action in the event of a fault, contact our customer service team who will assist you. The products serial number and proof of purchase must be provided. In the event of a faulty product, deXpro will replace faulty parts or at its sole discretion replace the product.

OPERATION

when using the Feisty Mini hand dryer please shake off any excess water before placing hands under air outlet, the dryer will start automatically when hands are placed under air outlet and stop automatically after hands have been removed.

- 1** Place hands under the outlet to start operation

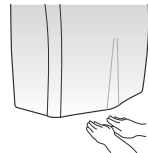

- 2** Slowly move hands back and forth through the air jet for a while.

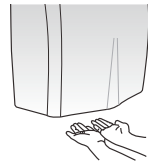

- 3** Rub hands lightly and rapidly.

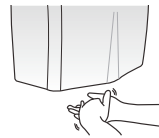

GENERAL SAFETY INFORMATION

Warning

1. Do not touch power source with wet hands.
2. Do not place foreign objects in the unit or use flammables cover the unit.
3. Young children or persons with physical, sensory or mental disabilities should be supervised when using the appliance.
4. If the power supply cord is damaged, it must be replaced by the manufacturer or its service agent or a qualified person in order to avoid a hazard.

PRODUCT FEATURES

1. Feisty Mini is particularly quiet in operation, whilst still maintaining a highly concentrated air stream, making it suitable for areas where loud noise would be disruptive.
2. The rotate speed of motor can reach 20000r/min, efficiently drying your hands within 10-15s
3. Contactless, hygienic operation which automatic starts when hand detected.
4. Flexible installation ensure maximum protection against vandalism and theft.

TECHNICAL SPECIFICATIONS

Rated Voltage: 220-240V	Rated Frequency: 50/60Hz
Rated Power : 1000W	Motor Power: 150W
Heating Element Power: 850W	Sensor Distance: 5-20cm
Environment Temperature: -5-50	Installation: Wall-mounted
Water Splash Proof: IPX1	Unit Size: 194*132*263mm

Packing List :

Main unit x 1	Install Screw x 4
Wall Mounting Bracket x 1	Expansion Pipe x 4

NAME OF COMPONENTS

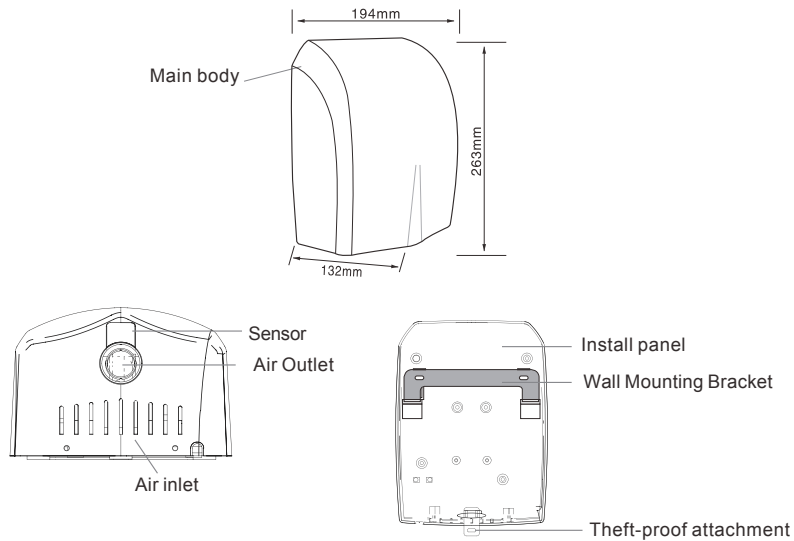

Notice Items Before Installation

Please protect yourself and others by observing all safety information



Failure to accurately follow the instructions before installing or servicing may result in fire, electric shock or personal injury.

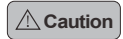

Improper mounting could result in personal injury and/or property damage.



- Do not use in locations where salt water damage may occur or where corrosives are present.
- Do not use in areas with high humidity and dustiness as well as avoid condensation on the product.
- Always disconnect the power source before servicing or installing the hand dryer
- Installation work must be done by qualified personnel in accordance with operation instructions
- Do not attempt to repair or take apart the hand dryer yourself

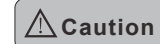

- The electrical installation must be carried out by a qualified electrician in accordance with the latest edition of the IEE wiring regulations.
- Electrical connection should be made to the fixed wiring of the property via a double pole switched fused spur.
- This product must be earthed.
- Install securely in a location strong enough to support the weight of the unit.
- Install the hand dryer on a smooth surface and in an area where people are not likely to collide with the object once installed.
- Do not install this hand dryer above sources of water such as sinks or taps.
- Ensure a clear space of at least 400mm around the air nozzle.
- This unit has been designed for indoor use only, protected from water, sun and extreme temperatures. Do not use outdoors or close to moisture and heat generators.

INSTALLATION

Select a desired height mounting location for the hand dryer (see mounting height recommendations)

Option 1: Using 4 screws and 4 expansion pipes to fixate the wall base plate

Option 2: Using 2 screws and 2 expansion pipes to fasten the mounting bracket attach the dryer then fasten the theft-proof attachment.

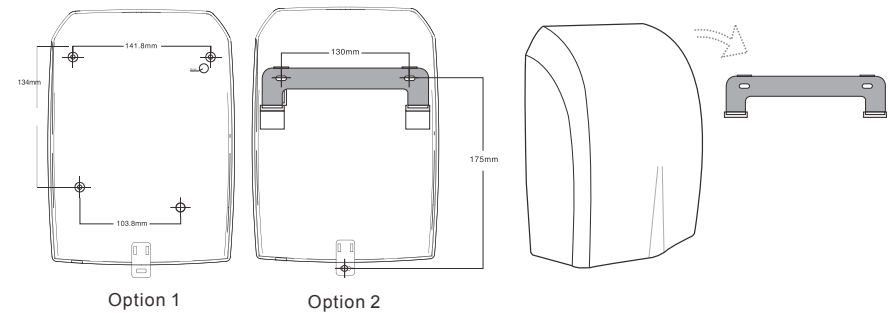

Recommended mounting heights

Men	50" (1270 mm)
Women	47" (1194 mm)
Children 11-16 years	41" (1040 mm)
Children 4-10 years	35" (890 mm)
Handicaped	40" (1016 mm)

